

Coolant Temperature System

WIRING SYSTEM

43. Coolant Temperature System

A: WIRING DIAGRAM

C/TEMP-01

C/TEMP-01

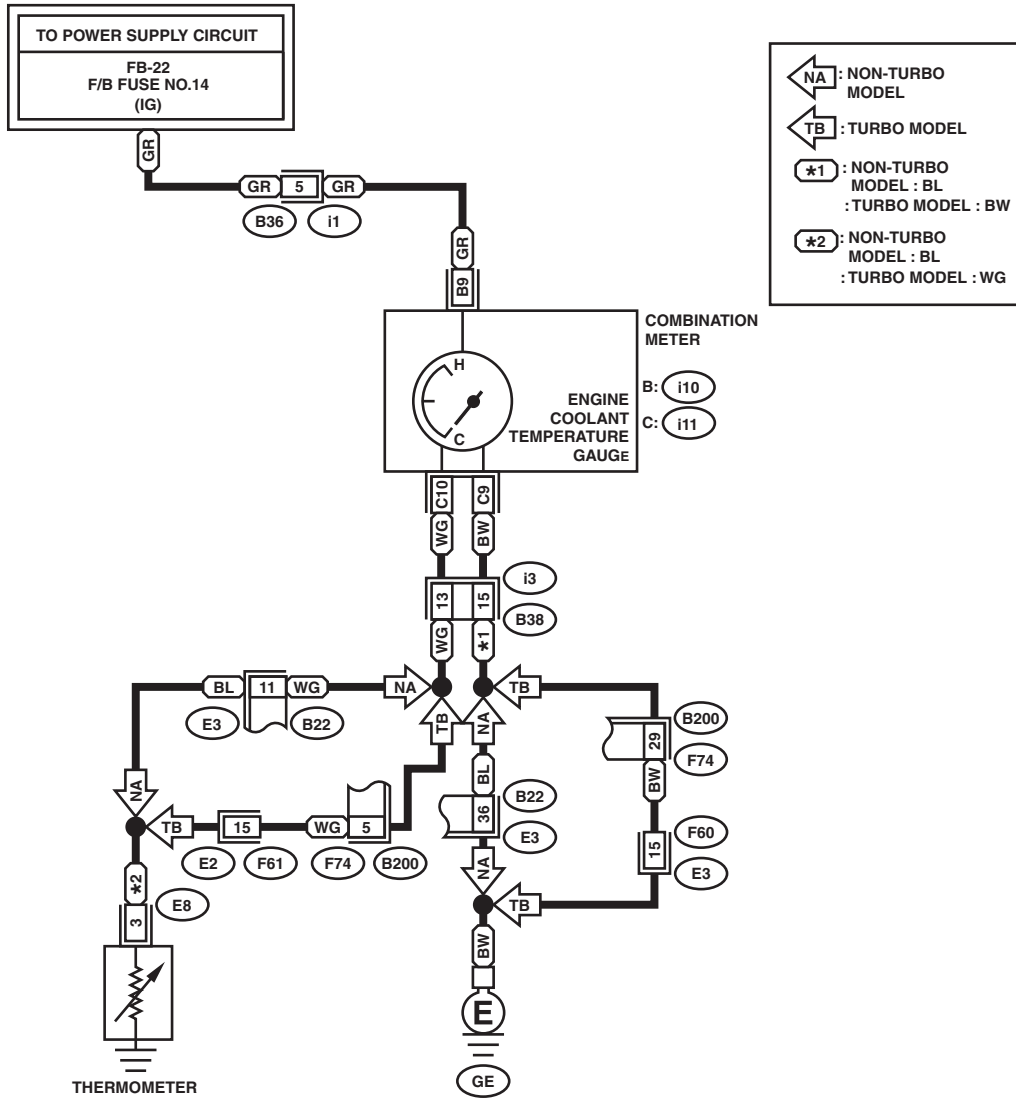

E8 (LIGHT GRAY)



C: i11 (GREEN)

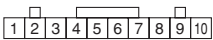

F60 HR (BROWN)

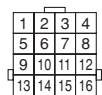

F61 HR (BLACK)

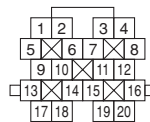

B36

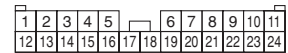

B: i10 (GREEN)

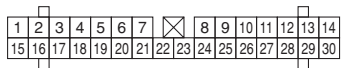

B38

F74



B22 (BLACK)

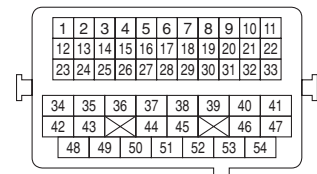

WI-11653