

Back-up Light System

WIRING SYSTEM

25. Back-up Light System

A: WIRING DIAGRAM

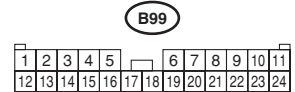
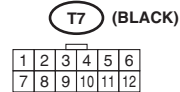
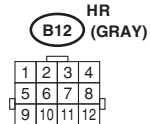
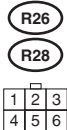
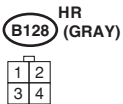
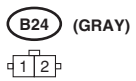
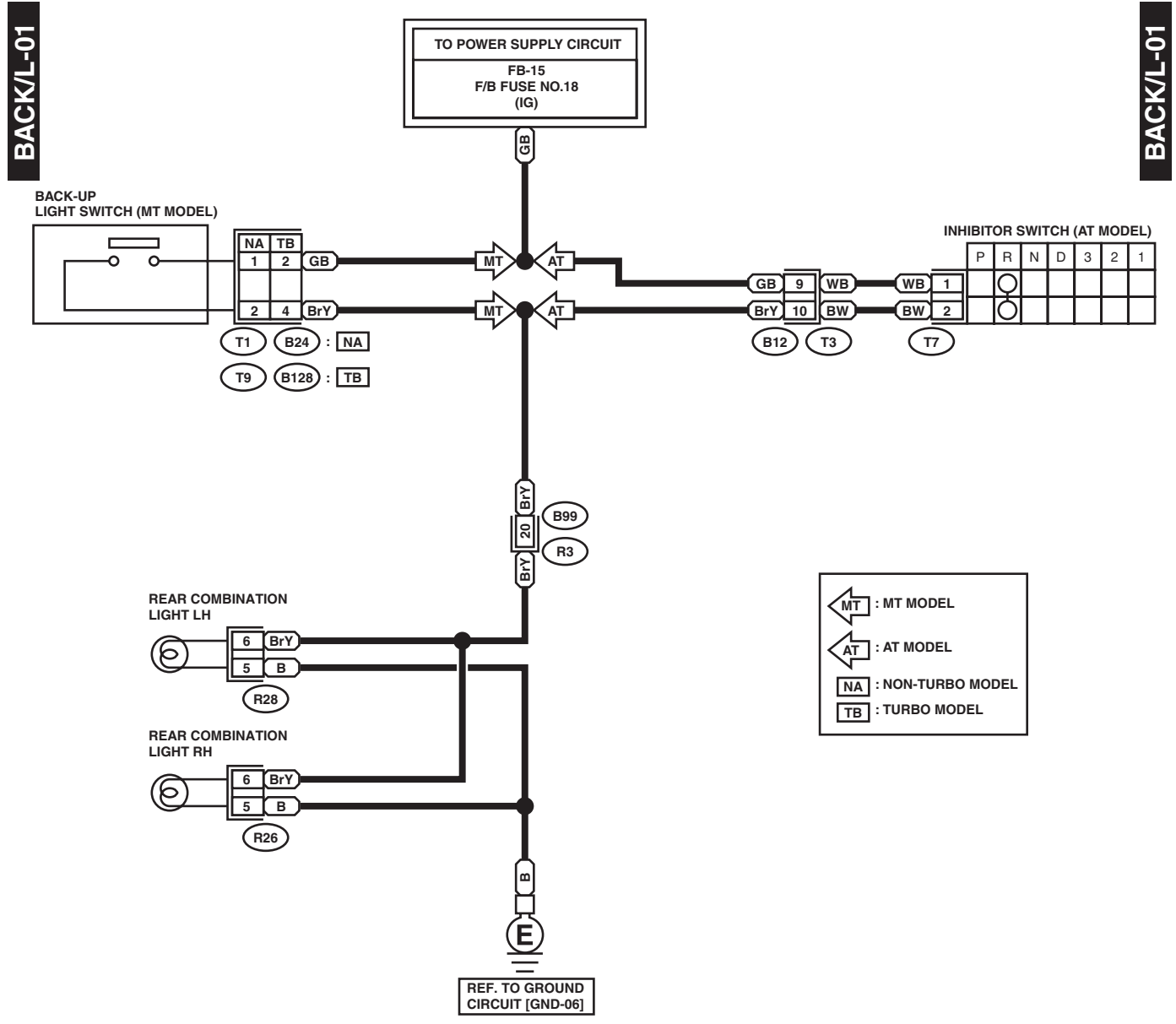

WI-11645