

General Description

MECHANICAL

1. General Description

A: SPECIFICATION

	Model		2.5 L		
Engine	Cylinder arrangement		Horizontally opposed, liquid cooled, 4-cylinder, 4-stroke gasoline engine		
	Valve system mechanism		Belt driven Single overhead camshaft 4-valve/cylinder		
	Bore × Stroke		mm (in) 99.5 × 79.0 (3.917 × 3.110)		
	Displacement		cm ³ (cu in) 2,457 (150)		
	Compression ratio		10.0		
	Compression pressure (at 350 rpm)		kPa (kg/cm ² , psi) 1,020 — 1,275 (10.4 — 13.0, 148 — 185)		
	Number of piston rings		Pressure ring: 2, Oil ring: 1		
	Intake valve timing		Constant	Open	BTDC 0°
				Close	ABDC 58°
			Low speed	Open	BTDC 0°
				Close	ABDC -50°
			High speed	Open	BTDC 14°
				Close	ABDC 62°
	Exhaust valve timing		Open	BBDC54°	
			Close	ATDC14°	
	Valve clearance		mm (in)	Intake	0.20±0.04 (0.0079±0.0016)
Exhaust				0.25±0.04 (0.0098±0.0016)	
Idling speed [at neutral position on MT, or "P" or "N" position on AT]		rpm	MT	650±100 (No load) 850±100 (A/C ON)	
			AT	700±100 (No load) 850±100 (A/C ON)	
Ignition order			1 → 3 → 2 → 4		
Ignition timing		BTDC/rpm	MT	10°±8°/650	
			AT	15°±8°/700	

NOTE:

US: undersize OS: oversize

General Description

MECHANICAL

Belt tension adjuster	Protrusion of adjuster rod		mm (in)	5.2 — 6.2 (0.205 — 0.244)		
Belt tensioner	Spacer O.D.		mm (in)	17.955 — 17.975 (0.7069 — 0.7077)		
	Tensioner bushing I.D.		mm (in)	18.00 — 18.08 (0.7087 — 0.7118)		
	Clearance between spacer and bushing:	mm (in)	Standard	0.025 — 0.125 (0.0010 — 0.0049)		
			Limit	0.175 (0.0069)		
Side clearance of spacer	mm (in)	Standard	0.20 — 0.55 (0.0079 — 0.0217)			
		Limit	0.81 (0.0319)			
Valve rocker arm	Clearance between shaft and arm	mm (in)	Standard	0.020 — 0.054 (0.0008 — 0.0021)		
			Limit	0.10 (0.0039)		
Camshaft	Bending limit		mm (in)	0.025 (0.00098)		
	Thrust clearance	mm (in)	Standard	0.030 — 0.090 (0.0012 — 0.0035)		
			Limit	0.10 (0.0039)		
	Cam lobe height	mm (in)	Intake	Constant	Standard Limit:	40.075 — 40.175 (1.5778 — 1.5817) 39.975 (1.5738)
				Low speed	Standard	35.182 — 35.282 (1.3851 — 1.3891)
					Limit:	35.085 (1.3812)
			High speed	Standard	40.315 — 40.415 (1.5872 — 1.5911)	
				Limit:	40.215 (1.5833)	
			Exhaust	Standard	40.149 — 40.249 (1.5807 — 1.5846)	
	Limit	40.049 (1.5767)				
	Camshaft journal O.D.		mm (in)	31.928 — 31.945 (1.2570 — 1.2577)		
Camshaft journal hole I.D.		mm (in)	32.000 — 32.018 (1.2598 — 1.2605)			
Oil clearance	mm (in)	Standard	0.055 — 0.090 (0.0022 — 0.0035)			
		Limit	0.10 (0.0039)			
Cylinder head	Surface warpage limit (Mating surface with cylinder block)		mm (in)	0.03 (0.001)		
	Grinding limit		mm (in)	0.1 (0.004)		
	Standard height		mm (in)	97.5 (3.84)		
Valve seat	Refacing angle			90°		
	Contacting width	mm (in)	Intake	Standard	0.8 — 1.4 (0.03 — 0.055)	
				Limit	1.7 (0.067)	
			Exhaust	Standard	1.2 — 1.8 (0.047 — 0.071)	
Limit				2.2 (0.087)		
Valve guide	Inside diameter		mm (in)	6.000 — 6.012 (0.2362 — 0.2367)		
	Protrusion above head	mm (in)	Intake	20.0 — 21.0 (0.787 — 0.827)		
			Exhaust	16.5 — 17.5 (0.650 — 0.689)		
Valve	Head edge thickness	mm (in)	Intake	Standard	0.8 — 1.2 (0.03 — 0.047)	
				Limit	0.6 (0.024)	
			Exhaust	Standard	1.0 — 1.4 (0.039 — 0.055)	
				Limit	0.6 (0.024)	
	Stem outer diameter	mm (in)	Intake	5.950 — 5.965 (0.2343 — 0.2348)		
			Exhaust	5.945 — 5.960 (0.2341 — 0.2346)		
	Valve stem gap	mm (in)	Standard	Intake	0.035 — 0.062 (0.0014 — 0.0024)	
				Exhaust	0.040 — 0.067 (0.0016 — 0.0026)	
Overall length	mm (in)		Limit	— 0.15 (0.0059)		
			Intake	120.6 (4.75)		
			Exhaust	121.7 (4.79)		

General Description

MECHANICAL

Valve spring	Free length		mm (in)	55.2 (2.173)	
	Squareness			2.5°, 2.4 (0.094) or less	
	Tension/spring height	N (kgf, lb)/mm (in)	Set	235.3 — 270.7 (24 — 27.6, 52.9 — 60.8)/45.0 (1.772)	
			Lift	578.9 — 639.9 (59.1 — 65.3, 130.3 — 143.9)/34.7 (1.366)	
Cylinder block	Surface warpage limit (mating with cylinder head)		mm (in)	0.025 (0.00098)	
	Grinding limit		mm (in)	0.1 (0.004)	
	Standard height		mm (in)	201.0 (7.91)	
	Cylinder inner diameter	mm (in)	Standard	A 99.505 — 99.515 (3.9175 — 3.9179) B 99.495 — 99.505 (3.9171 — 3.9175)	
			Taper	mm (in)	Standard 0.015 (0.0006) Limit 0.050 (0.0020)
	Out-of-roundness	mm (in)	Standard	0.010 (0.0004)	
			Limit	0.050 (0.0020)	
	Piston clearance	mm (in)	Standard	-0.010 — 0.010 (-0.00039 — 0.00039)	
			Limit	0.030 (0.0012)	
Boring limit		mm (in)	0.5 (0.020)		
Piston	Outer diameter	mm (in)	Standard	A 99.505 — 99.515 (3.9175 — 3.9179) B 99.495 — 99.505 (3.9171 — 3.9175)	
			0.25 (0.0098) OS	99.745 — 99.765 (3.9270 — 3.9278)	
		0.50 (0.0197) OS	99.995 — 100.015 (3.9368 — 3.9376)		
		Piston pin specified diameter		mm (in)	23.000 — 23.006 (0.9055 — 0.9057)
Piston pin	Outer diameter		mm (in)	22.994 — 23.000 (0.9053 — 0.9055)	
	Clearance between piston and piston pin:	mm (in)	Standard	0.004 — 0.008 (0.0002 — 0.0003)	
			Limit	0.020 (0.0008)	
	Degree of fit			Piston pin must be fitted into position with thumb at 20°C (68°F).	
Piston ring	Ring closed gap	mm (in)	Top ring	Standard 0.20 — 0.35 (0.0079 — 0.0138) Limit 1.0 (0.039)	
			Second ring	Standard 0.37 — 0.52 (0.0144 — 0.0203) Limit 1.0 (0.039)	
		Oil ring	Standard	0.20 — 0.50 (0.0079 — 0.0197)	
			Limit	1.5 (0.059)	
		Ring groove gap	mm (in)	Top ring	Standard 0.040 — 0.080 (0.0016 — 0.0031) Limit 0.15 (0.0059)
				Second ring	Standard 0.030 — 0.070 (0.0012 — 0.0028) Limit 0.15 (0.0059)
	Connecting rod	Bend or twist per 100 mm (3.94 in) in length		mm (in)	Limit 0.10 (0.0039)
		Side clearance of large end		mm (in)	Standard 0.070 — 0.330 (0.0028 — 0.0130) Limit 0.4 (0.016)
Bearing of large end	Oil clearance	mm (in)	Standard	0.016 — 0.044 (0.00063 — 0.0017)	
			Limit	0.05 (0.0020)	
	Bearing size (Thickness at center)	mm (in)	Standard	1.492 — 1.501 (0.0587 — 0.0591)	
			0.03 (0.0012) US	1.510 — 1.513 (0.0594 — 0.0596)	
			0.05 (0.0020) US	1.520 — 1.523 (0.0598 — 0.0600)	
0.25 (0.0098) US	1.620 — 1.623 (0.0638 — 0.0639)				
Bushing of small end	Clearance between piston pin and bushing		mm (in)	Standard 0 — 0.022 (0 — 0.0009) Limit 0.030 (0.0012)	

General Description

MECHANICAL

Crankshaft	Bend limit		mm (in)	0.035 (0.0014)		
	Crank pin	Out-of-roundness		mm (in)	0.003 (0.0001)	
		Cylindricity		mm (in)	0.004 (0.0002)	
		Grinding limit (dia.)		mm (in)	To 51.750 (2.0374)	
	Crank journal	Out-of-roundness		mm (in)	0.005 (0.0002)	
		Cylindricity		mm (in)	0.006 (0.0002)	
		Grinding limit (dia.)		mm (in)	To 59.750 (2.3524)	
	Crank pin outer diameter	mm (in)	Standard		51.984 — 52.000 (2.0466 — 2.0472)	
			0.03 (0.0012) US		51.954 — 51.970 (2.0454 — 2.0461)	
			0.05 (0.0020) US		51.934 — 51.950 (2.0446 — 2.0453)	
			0.25 (0.0098) US		51.734 — 51.750 (2.0368 — 2.0374)	
	Crank journal outer diameter	mm (in)	Standard		59.992 — 60.008 (2.3619 — 2.3625)	
			0.03 (0.0012) US		59.962 — 59.978 (2.3607 — 2.3613)	
			0.05 (0.0020) US		59.942 — 59.958 (2.3599 — 2.3605)	
			0.25 (0.0098) US		59.742 — 59.758 (2.3520 — 2.3527)	
	Thrust clearance	mm (in)	Standard		0.030 — 0.115 (0.0012 — 0.0045)	
			Limit		0.25 (0.0098)	
Oil clearance	mm (in)	Standard		0.010 — 0.030 (0.0001 — 0.0012)		
		Limit		0.40 (0.016)		
Main bearing	Main bearing	#1, #3	mm (in)		Standard	1.998 — 2.011 (0.0787 — 0.0792)
			0.03 (0.0012) US		2.017 — 2.020 (0.0794 — 0.0795)	
			0.05 (0.0020) US		2.027 — 2.030 (0.0798 — 0.0799)	
			0.25 (0.0098) US		2.127 — 2.130 (0.0837 — 0.0839)	
		#2, #4, #5	Standard		2.000 — 2.013 (0.0787 — 0.0793)	
			0.03 (0.0012) US		2.019 — 2.022 (0.0795 — 0.0796)	
			0.05 (0.0020) US		2.029 — 2.032 (0.0799 — 0.0800)	
			0.25 (0.0098) US		2.129 — 2.132 (0.0838 — 0.0839)	

General Description

MECHANICAL

B: COMPONENT

1. TIMING BELT

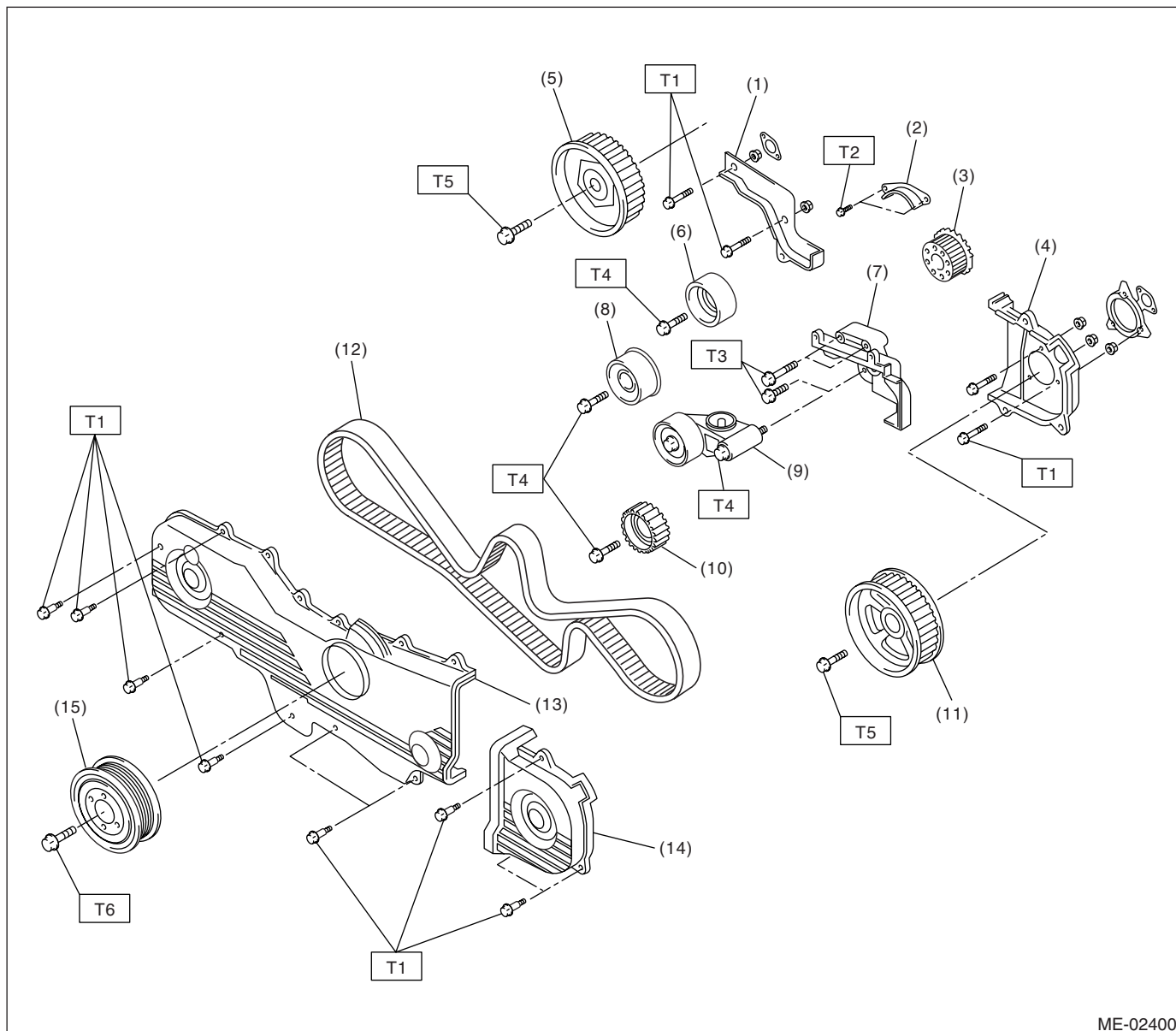

ME-02400

- | | |
|----------------------------------|-----------------------------------|
| (1) Timing belt cover No. 2 (RH) | (9) Automatic belt tensioner ASSY |
| (2) Timing belt guide (MT model) | (10) Belt idler No. 2 |
| (3) Crank sprocket | (11) Cam sprocket No. 2 |
| (4) Timing belt cover No. 2 (LH) | (12) Timing belt |
| (5) Cam sprocket No. 1 | (13) Front timing belt cover |
| (6) Belt idler (No. 1) | (14) Timing belt cover (LH) |
| (7) Tensioner bracket | (15) Crank pulley |
| (8) Belt idler (No. 2) | |

Tightening torque: N·m (kgf·m, ft·lb)

T1: 5 (0.5, 3.6)

T2: 9.75 (1.0, 7.2)

T3: 24.5 (2.5, 18.1)

T4: 39 (4.0, 28.9)

T5: 78 (8.0, 57.9)

T6: <Ref. to ME(H4SO)-39, INSTALLATION, Crank Pulley.>

ME(H4SO)-6

2. CYLINDER HEAD AND CAMSHAFT

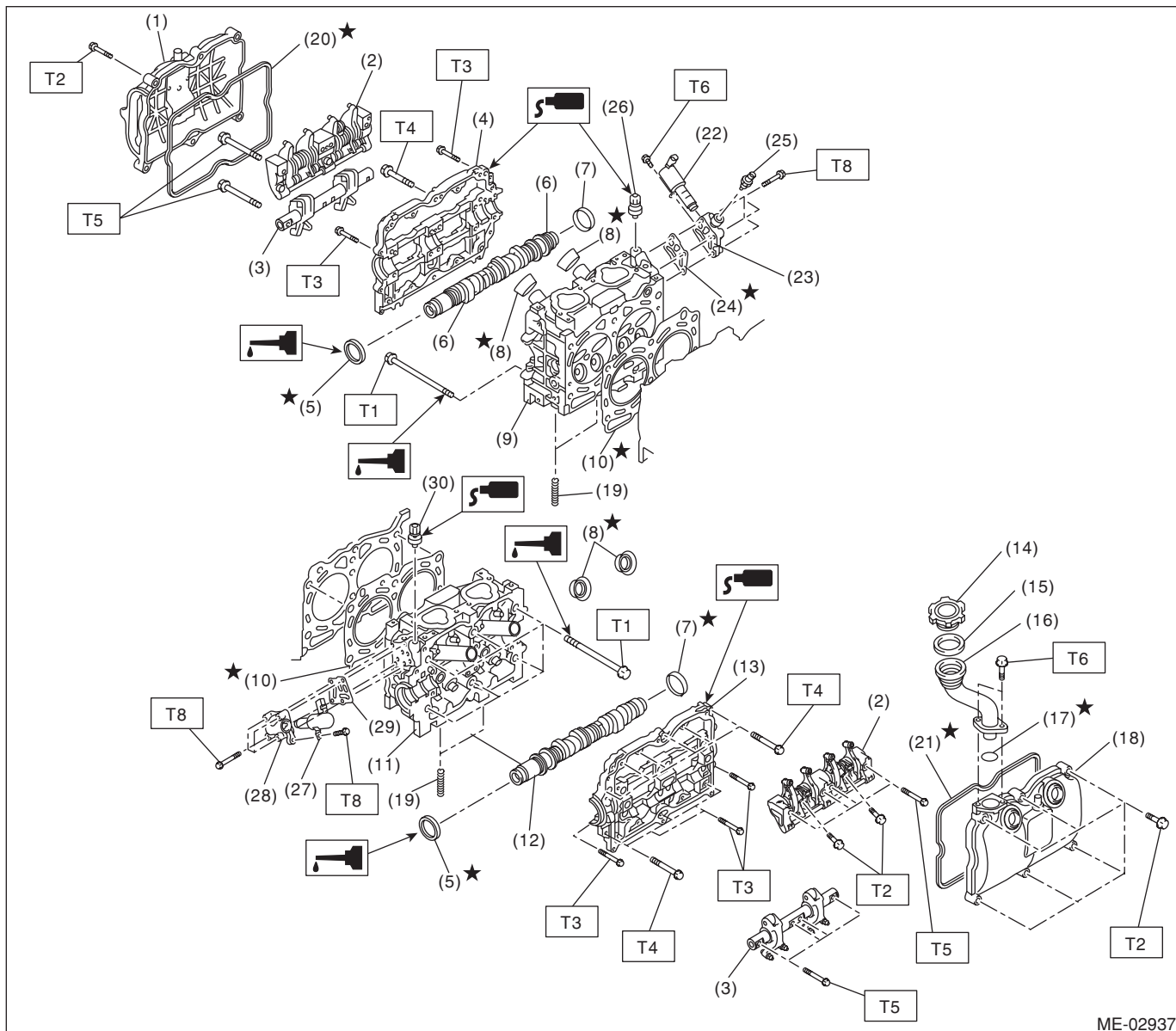

ME-02937

- | | | |
|-------------------------------|---|---|
| (1) Rocker cover (RH) | (17) O-ring | (30) Variable valve lift diagnosis oil pressure switch (LH) |
| (2) Intake valve rocker ASSY | (18) Rocker cover (LH) | |
| (3) Exhaust valve rocker ASSY | (19) Stud bolt | |
| (4) Camshaft cap (RH) | (20) Rocker cover gasket (RH) | |
| (5) Oil seal | (21) Rocker cover gasket (LH) | |
| (6) Camshaft (RH) | (22) Oil switching solenoid valve (RH) | |
| (7) Plug | (23) Oil switching solenoid valve holder (RH) | |
| (8) Spark plug pipe gasket | (24) Gasket | |
| (9) Cylinder head (RH) | (25) Oil temperature sensor | |
| (10) Cylinder head gasket | (26) Variable valve lift diagnosis oil pressure switch (RH) | |
| (11) Cylinder head (LH) | (27) Oil switching solenoid valve (LH) | |
| (12) Camshaft (LH) | (28) Oil switching solenoid valve holder (LH) | |
| (13) Camshaft cap (LH) | (29) Gasket | |
| (14) Oil filler cap | | |
| (15) Gasket | | |
| (16) Oil filler duct | | |

Tightening torque: N-m (kgf-m, ft-lb)

T1: <Ref. to ME(H4SO)-56, INSTALLATION, Cylinder Head.>

T2: <Ref. to ME(H4SO)-48, INSTALLATION, Valve Rocker Assembly.>

T3: 9.75 (1.0, 7.2)

T4: 18 (1.8, 13.0)

T5: 25 (2.5, 18.1)

T6: 6.4 (0.65, 4.7)

T7: 8 (0.8, 5.9)

T8: 10 (1.0, 7.4)

General Description

MECHANICAL

3. VALVE ROCKER ASSEMBLY

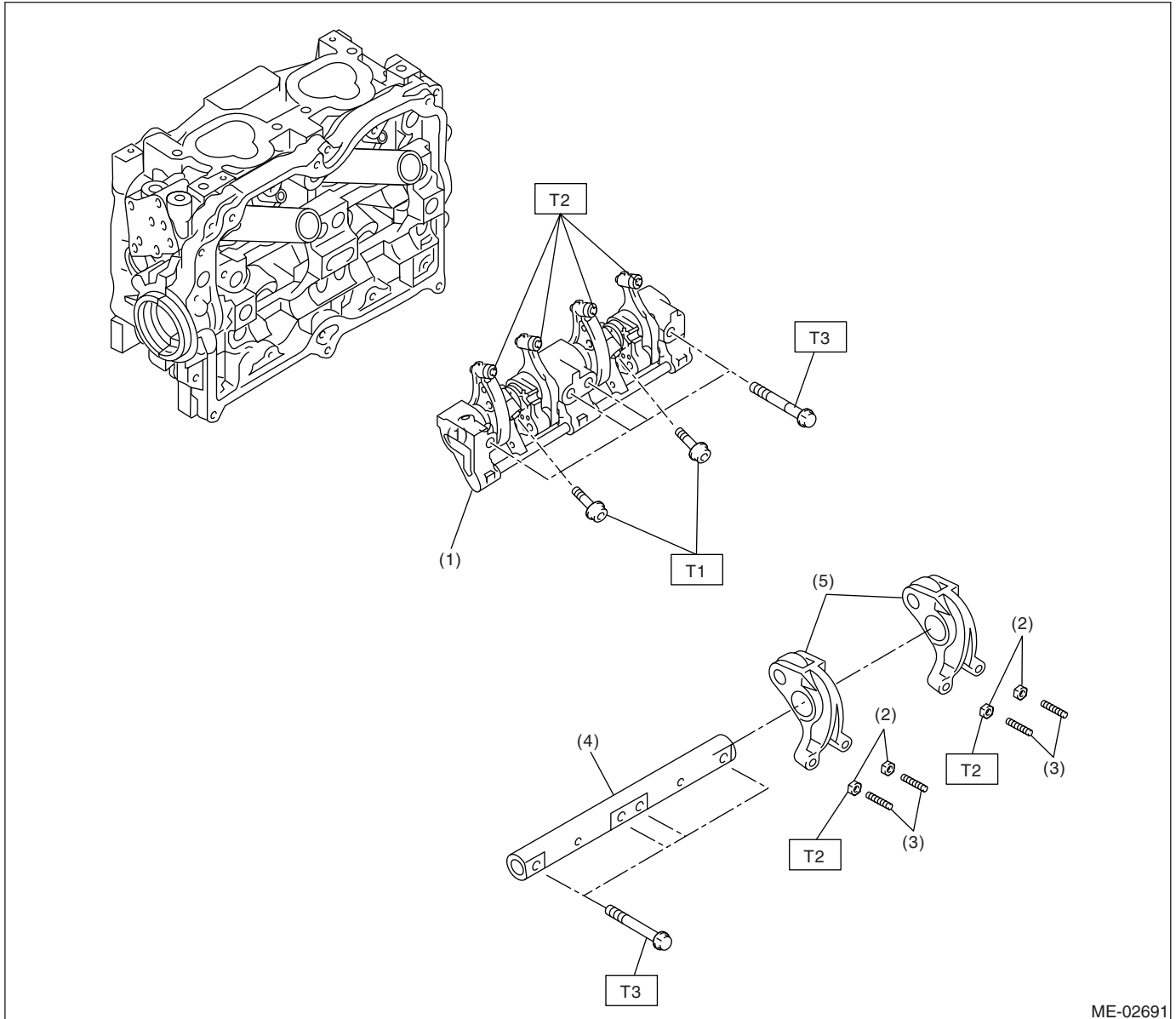

ME-02691

- (1) Intake valve rocker arm ASSY
- (2) Valve rocker nut
- (3) Valve rocker adjusting screw
- (4) Exhaust rocker shaft
- (5) Exhaust valve rocker arm

Tightening torque: N·m (kgf·m, ft·lb)

T1: 8 (0.8, 5.9)

T2: 9.75 (1.0, 7.2)

T3: 25 (2.5, 18.1)

4. CYLINDER HEAD AND VALVE ASSEMBLY

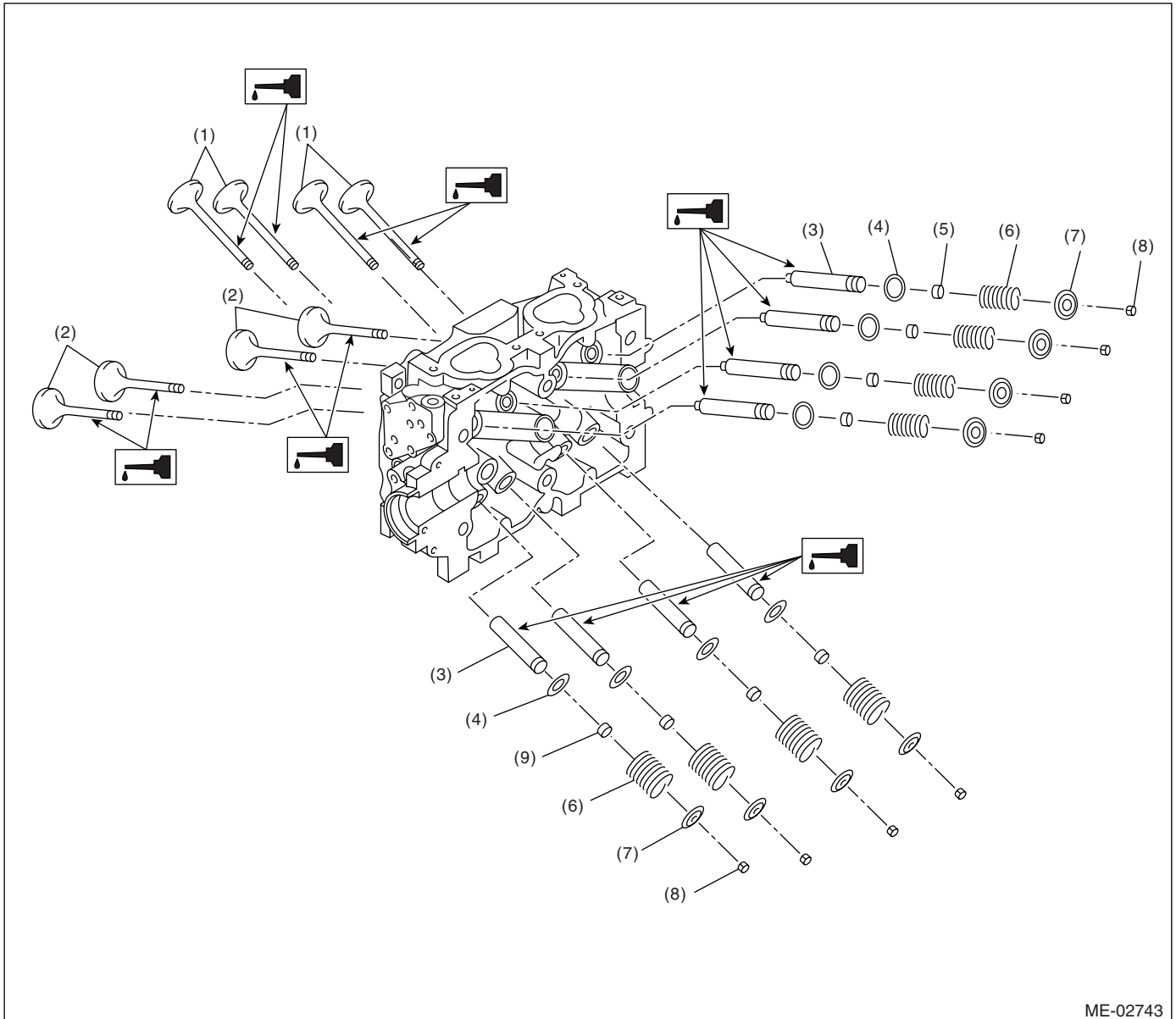

ME-02743

- | | | |
|-------------------|---------------------------|----------------------------|
| (1) Exhaust valve | (4) Valve spring seat | (7) Retainer |
| (2) Intake valve | (5) Intake valve oil seal | (8) Retainer key |
| (3) Valve guide | (6) Valve spring | (9) Exhaust valve oil seal |

General Description

MECHANICAL

5. CYLINDER BLOCK

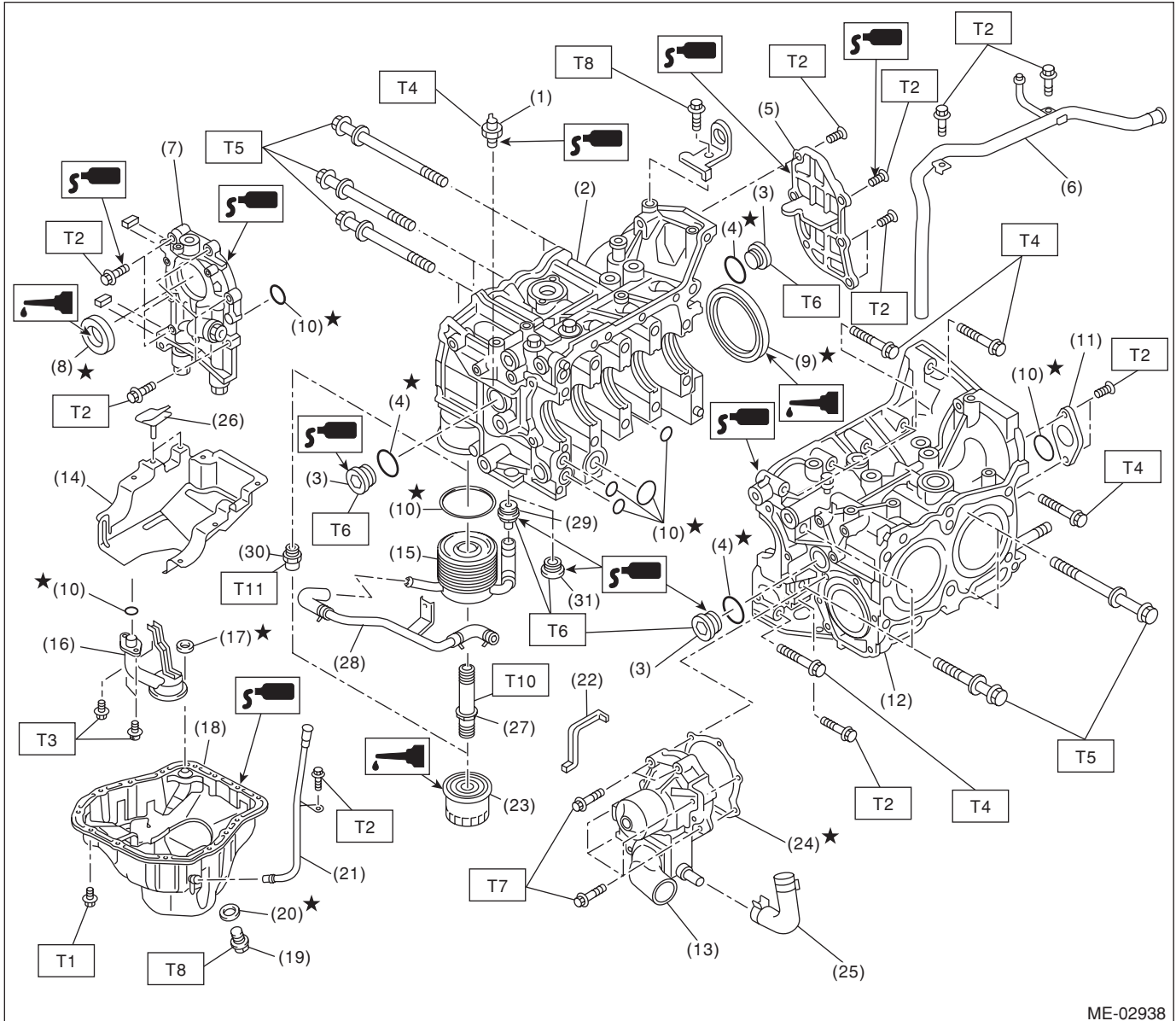

ME-02938

- | | |
|----------------------------|-----------------------------------|
| (1) Oil pressure switch | (17) Gasket |
| (2) Cylinder block (RH) | (18) Oil pan |
| (3) Service hole plug | (19) Drain plug |
| (4) Gasket | (20) Metal gasket |
| (5) Oil separator cover | (21) Oil level gauge guide |
| (6) Water by-pass pipe | (22) Water pump sealing |
| (7) Oil pump | (23) Oil filter |
| (8) Front oil seal | (24) Gasket |
| (9) Rear oil seal | (25) Water pump hose |
| (10) O-ring | (26) Seal |
| (11) Service hole cover | (27) Connector (AT model) |
| (12) Cylinder block (LH) | (28) Water bypass pipe (AT model) |
| (13) Water pump | (29) Plug (AT model) |
| (14) Baffle plate | (30) Connector (MT model) |
| (15) Oil cooler (AT model) | (31) Plug (MT model) |
| (16) Oil strainer | |

Tightening torque: N-m (kgf-m, ft-lb)

T1: 5 (0.5, 3.6)

T2: 6.4 (0.65, 4.7)

T3: 10 (1.0, 7.2)

T4: 25 (2.5, 18.1)

**T5: <Ref. to ME(H4SO)-68, INSTAL-
LATION, Cylinder Block.>**

T6: 70 (7.1, 50.6)

T7: First 12 (1.2, 8.7)

Second 12 (1.2, 8.7)

T8: 16 (1.6, 11.6)

T9: 44 (4.5, 33)

T10: 54 (5.5, 40)

T11: 45 (4.6, 33.3)

ME(H4SO)-10

6. CRANKSHAFT AND PISTON

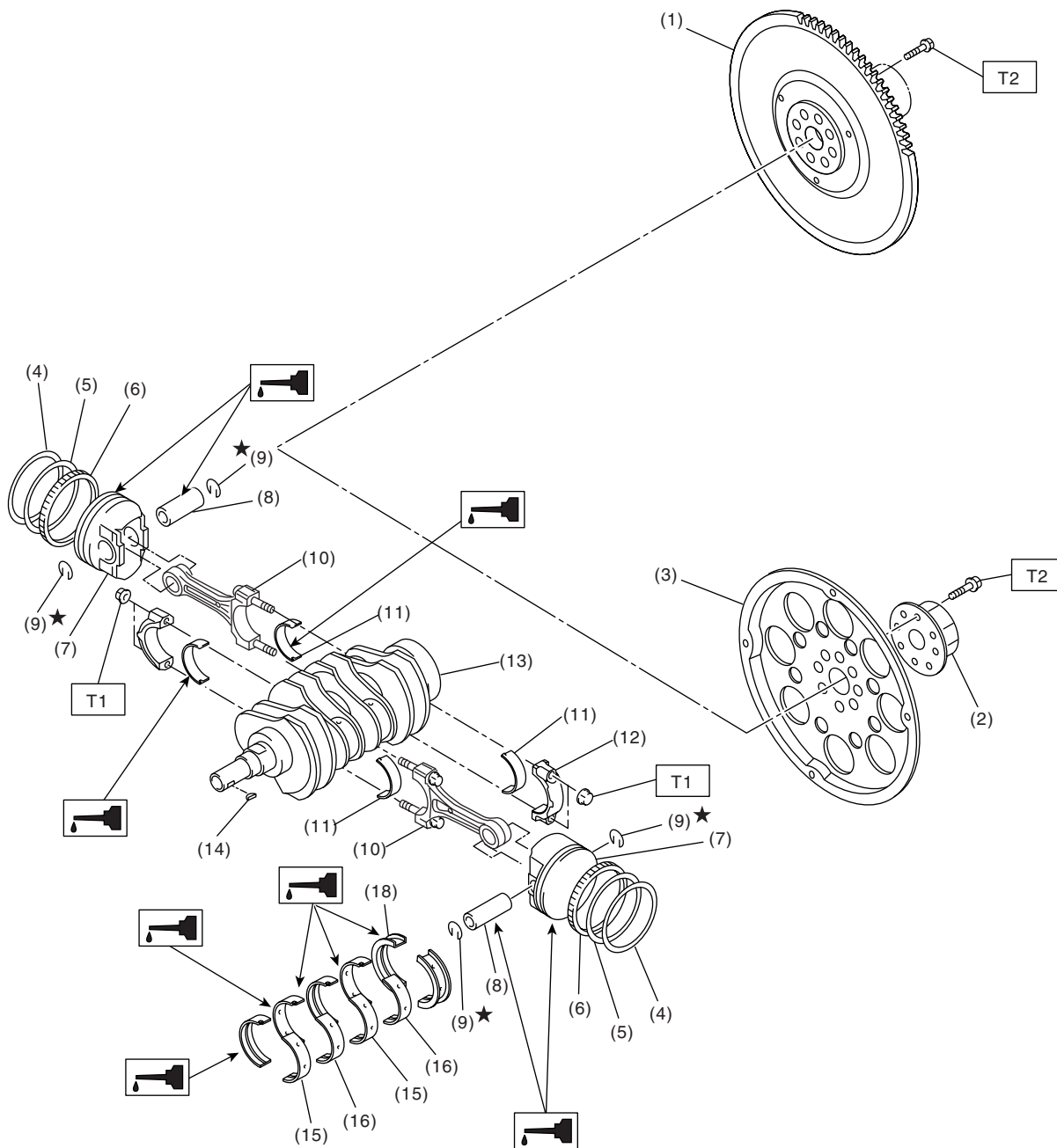

ME-02693

- | | | |
|------------------------------|-----------------------------|--------------------------------|
| (1) Flywheel (MT model) | (8) Piston pin | (15) Crankshaft bearing #1, #3 |
| (2) Reinforcement (AT model) | (9) Snap ring | (16) Crankshaft bearing #2, #4 |
| (3) Drive plate (AT model) | (10) Connecting rod | (17) Crankshaft bearing #5 |
| (4) Top ring | (11) Connecting rod bearing | |
| (5) Second ring | (12) Connecting rod cap | |
| (6) Oil ring | (13) Crankshaft | |
| (7) Piston | (14) Woodruff key | |

Tightening torque: N·m (kgf·m, ft·lb)

T1: 45 (4.6, 33.3)

T2: 72 (7.3, 52.8)

General Description

MECHANICAL

7. ENGINE MOUNTING

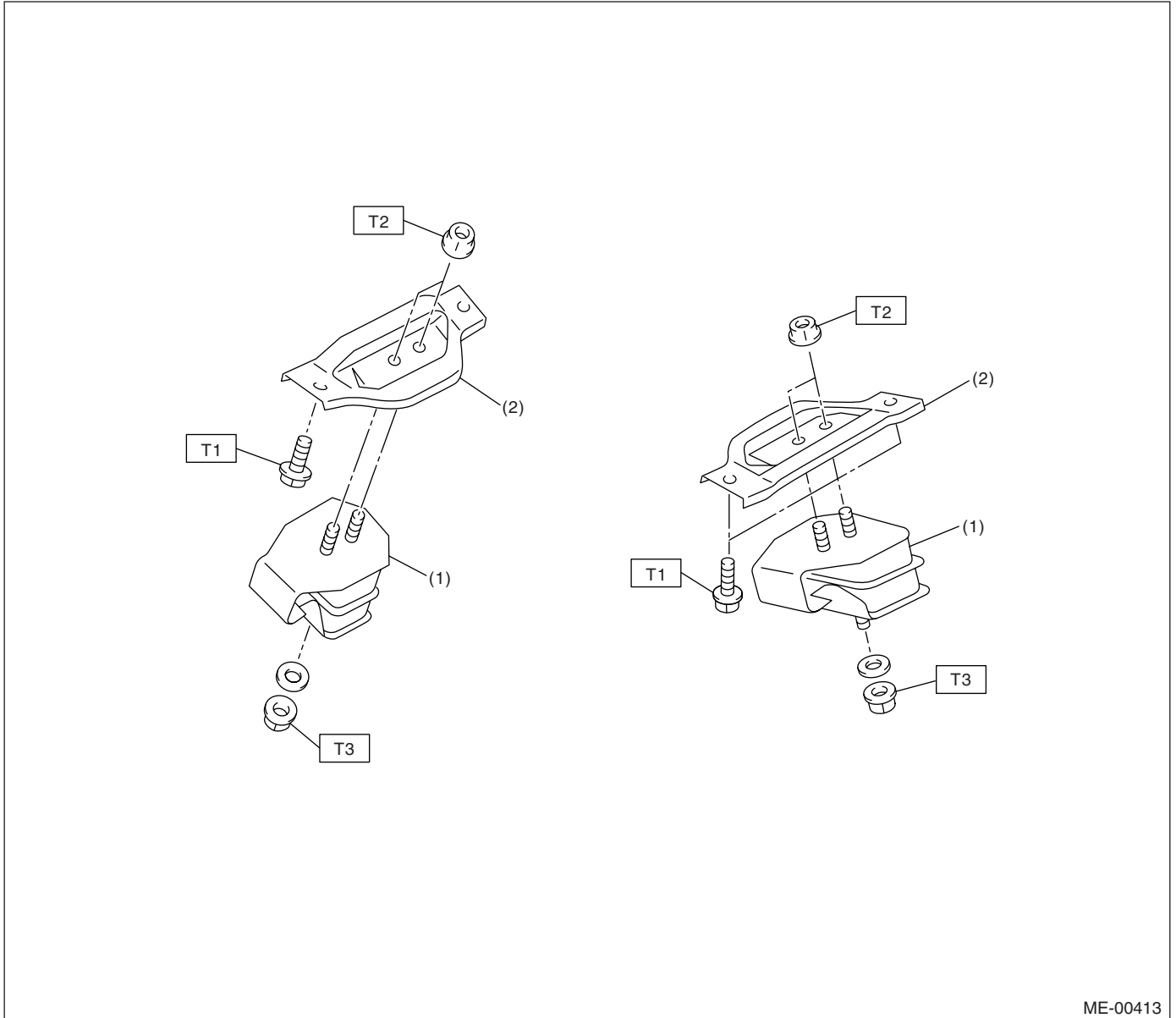

ME-00413

- (1) Front cushion rubber
- (2) Front engine mounting bracket

Tightening torque: N·m (kgf·m, ft·lb)

T1: 35 (3.6, 25.8)

T2: 42 (4.3, 31.0)

T3: 85 (8.7, 63)

C: CAUTION

- Wear work clothing, including a cap, protective goggles and protective shoes during operation.
- Remove contamination including dirt and corrosion before removal, installation or disassembly.
- Keep the disassembled parts in order and protect them from dust and dirt.
- Before removal, installation or disassembly, be sure to clarify the failure. Avoid unnecessary removal, installation, disassembly and replacement.
- Be careful not to burn yourself, because each part on the vehicle is hot after running.
- Be sure to tighten fasteners including bolts and nuts to the specified torque.
- Place shop jacks or rigid racks at the specified points.
- Before disconnecting connectors of sensors or units, be sure to disconnect the ground cable from battery.
- All parts should be thoroughly cleaned, paying special attention to engine oil passages, pistons and bearings.
- Rotating parts and sliding parts such as piston, bearing and gear should be coated with oil prior to assembly.
- Be careful not to let oil, grease or coolant contact the timing belt, clutch disc and flywheel.
- All removed parts, if to be reused, should be reinstalled in the original positions and directions.
- Bolts, nuts and washers should be replaced with new ones as required.
- Even if necessary inspections have been made in advance, proceed with assembly work while making re-checks.
- Remove or install the engine in an area where chain hoists, lifting devices, etc. are available for ready use.
- Be sure not to damage coated surfaces of body panels with tools, or not to stain seats and windows with coolant or oil. Place a cover over fender, as required, for protection.
- Prior to starting work, prepare the following:
Service tools, clean cloth, containers to catch coolant and oil, wire ropes, chain hoist, transmission jacks, etc.
- Lift-up or lower the vehicle when necessary. Make sure to support the correct positions.

D: PREPARATION TOOL

1. SPECIAL TOOL

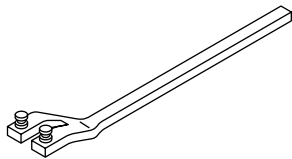
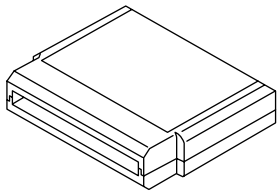
ILLUSTRATION	TOOL NUMBER	DESCRIPTION	REMARKS
 ST18231AA010	18231AA010	CAM SPROCKET WRENCH	<ul style="list-style-type: none"> • Used for removing and installing cam sprocket. (LH side) • CAMSHAFT SPROCKET WRENCH (499207100) can also be used.
 ST18482AA010	18482AA010	CARTRIDGE	Troubleshooting for electrical system.

General Description

MECHANICAL

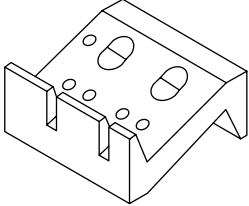
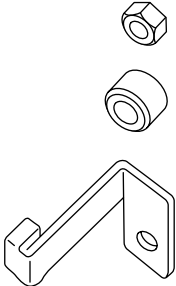
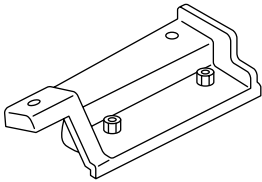
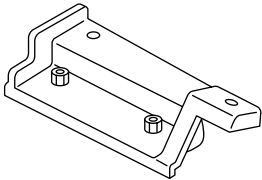
ILLUSTRATION	TOOL NUMBER	DESCRIPTION	REMARKS
 <p style="text-align: center;">ST22771AA030</p>	22771AA030	SUBARU SELECT MONITOR KIT	Troubleshooting for electrical system.
 <p style="text-align: center;">ST-498267800</p>	498267800	CYLINDER HEAD TABLE	<ul style="list-style-type: none"> • Used for replacing valve guides. • Used for removing and installing valve spring.
 <p style="text-align: center;">ST-498277200</p>	498277200	STOPPER SET	Used for installing automatic transmission assembly to engine.
 <p style="text-align: center;">ST-498457000</p>	498457000	ENGINE STAND ADAPTER RH	Used with ENGINE STAND (499817100).
 <p style="text-align: center;">ST-498457100</p>	498457100	ENGINE STAND ADAPTER LH	Used with ENGINE STAND (499817100).

General Description

MECHANICAL

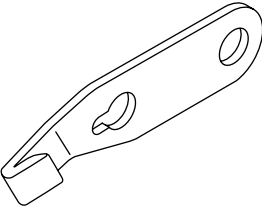
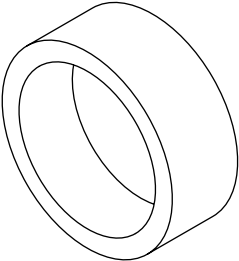
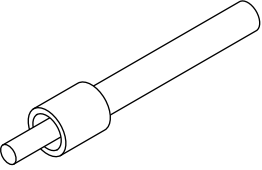
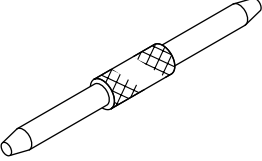
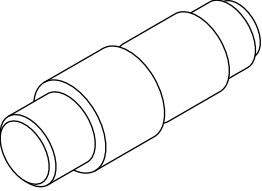
ILLUSTRATION	TOOL NUMBER	DESCRIPTION	REMARKS
 <p style="text-align: center;">ST-498497100</p>	498497100	CRANKSHAFT STOPPER	Used for stopping rotation of the flywheel when loosening/tightening crank pulley bolt.
 <p style="text-align: center;">ST-498747300</p>	498747300	PISTON GUIDE	Used for installing piston in cylinder.
 <p style="text-align: center;">ST-498857100</p>	498857100	VALVE OIL SEAL GUIDE	Used for press-fitting of intake and exhaust valve guide oil seals.
 <p style="text-align: center;">ST-499017100</p>	499017100	PISTON PIN GUIDE	Used for installing piston pin, piston and connecting rod.
 <p style="text-align: center;">ST-499037100</p>	499037100	CONNECTING ROD BUSHING REMOVER & INSTALLER	Used for removing and installing connecting rod bushing.

General Description

MECHANICAL

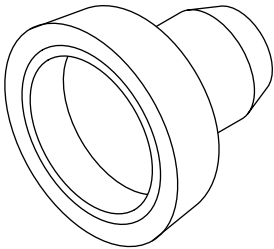
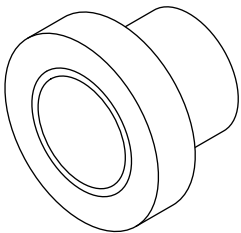
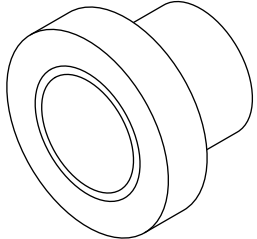
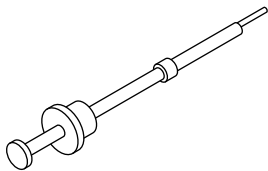
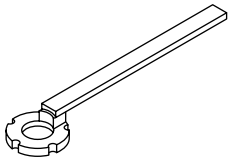
ILLUSTRATION	TOOL NUMBER	DESCRIPTION	REMARKS
 <p style="text-align: center;">ST-499587200</p>	499587200	CRANKSHAFT OIL SEAL INSTALLER	<ul style="list-style-type: none"> • Used for installing crankshaft oil seal. • Used with CRANKSHAFT OIL SEAL GUIDE (499597100).
 <p style="text-align: center;">ST-499587500</p>	499587500	OIL SEAL INSTALLER	<ul style="list-style-type: none"> • Used for installing CAMSHAFT oil seal. • Used with OIL SEAL GUIDE (499597000).
 <p style="text-align: center;">ST-499587700</p>	499587700	CAMSHAFT OIL SEAL INSTALLER	Used for installing cylinder head plug.
 <p style="text-align: center;">ST-499097700</p>	499097700	PISTON PIN REMOVER ASSY	Used for removing piston pin.
 <p style="text-align: center;">ST-499207400</p>	499207400	CAM SPROCKET WRENCH	Used for removing and installing cam sprocket. (RH side)

General Description

MECHANICAL

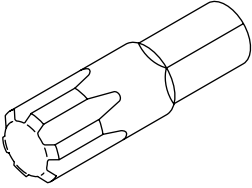
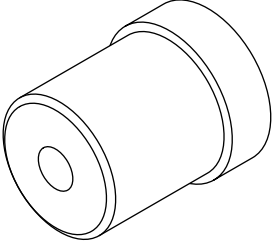
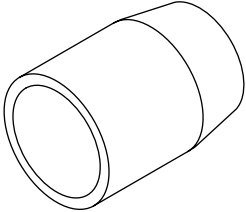
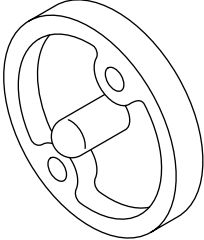
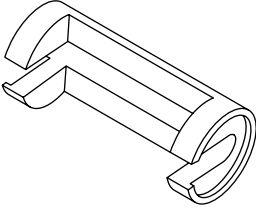
ILLUSTRATION	TOOL NUMBER	DESCRIPTION	REMARKS
 <p>ST-499497000</p>	499497000	TORX® PLUS	Used for removing and installing camshaft cap.
 <p>ST-499587100</p>	499587100	OIL SEAL INSTALLER	Used for installing oil pump oil seal.
 <p>ST-499597000</p>	499597000	OIL SEAL GUIDE	<ul style="list-style-type: none"> • Used for installing camshaft oil seal. • Used with camshaft OIL SEAL INSTALLER (499587500).
 <p>ST-499597100</p>	499597100	CRANKSHAFT OIL SEAL GUIDE	<ul style="list-style-type: none"> • Used for installing crankshaft oil seal. • Used with CRANKSHAFT OIL SEAL INSTALLER (499587200).
 <p>ST-499718000</p>	499718000	VALVE SPRING REMOVER	Used for removing and installing valve spring.

General Description

MECHANICAL

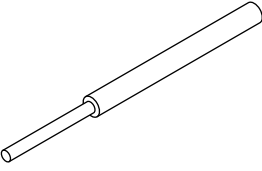
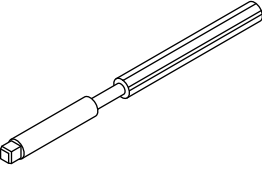
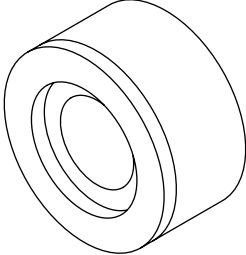
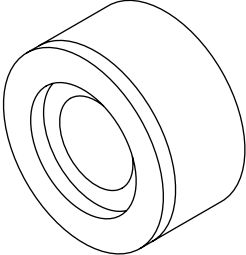
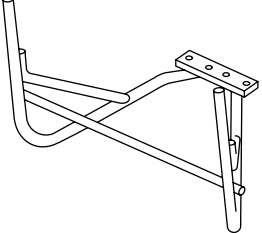
ILLUSTRATION	TOOL NUMBER	DESCRIPTION	REMARKS
 <p style="text-align: center;">ST-499767200</p>	499767200	VALVE GUIDE REMOVER	Used for removing valve guides.
 <p style="text-align: center;">ST-499767400</p>	499767400	VALVE GUIDE REAMER	Used for reaming valve guides.
 <p style="text-align: center;">ST-499767700</p>	499767700	VALVE GUIDE ADJUSTER	Used for installing valve guides. (Intake side)
 <p style="text-align: center;">ST-499767800</p>	499767800	VALVE GUIDE ADJUSTER	Used for installing valve guides. (Exhaust side)
 <p style="text-align: center;">ST-499817100</p>	499817100	ENGINE STAND	<ul style="list-style-type: none"> • Stand used for engine disassembly and assembly. • Used with ENGINE STAND ADAPTER RH (498457000) & LH (498457100).

General Description

MECHANICAL

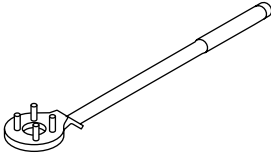
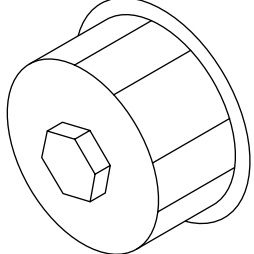
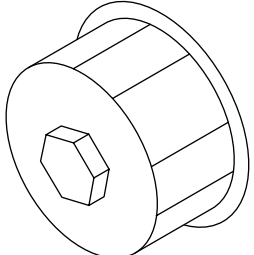
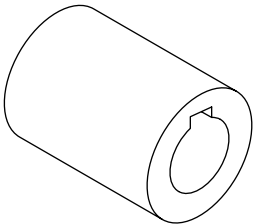
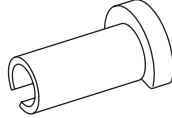
ILLUSTRATION	TOOL NUMBER	DESCRIPTION	REMARKS
 <p data-bbox="337 514 467 535">ST-499977100</p>	499977100	CRANK PULLEY WRENCH	Used for stopping rotation of crank pulley when loosening/tightening crank pulley bolt.
 <p data-bbox="324 871 462 892">ST18332AA000</p>	18332AA000	OIL FILTER WRENCH	Used for removing and installing oil filter. (Outer diameter: 68 mm (2.68 in))
 <p data-bbox="324 1218 462 1239">ST18332AA010</p>	18332AA010	OIL FILTER WRENCH	Used for removing and installing oil filter. (Outer diameter: 65 mm (2.56 in))
 <p data-bbox="337 1564 467 1585">ST-499987500</p>	499987500	CRANKSHAFT SOCKET	Used for rotating crankshaft.
 <p data-bbox="316 1921 470 1942">ST42099AE000</p>	42099AE000	CONNECTOR REMOVER	Used for removing the quick connector.

General Description

MECHANICAL

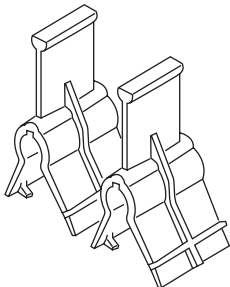
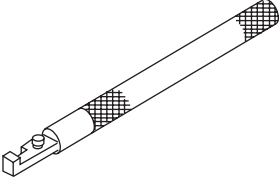
ILLUSTRATION	TOOL NUMBER	DESCRIPTION	REMARKS
 <p style="text-align: center;">ST18354AA000</p>	18354AA000	VALVE ROCKER HOLDER	Used for installing the valve rocker assembly (intake). (2 sets)
 <p style="text-align: center;">ST18258AA000</p>	18258AA000	SPRING INSTALLER	Used for installing the valve rocker assembly (intake).

2. GENERAL TOOL

TOOL NAME	REMARKS
Compression gauge	Used for measuring compression.
Vacuum gauge	Used for measuring negative pressure.
Oil pressure gauge	Used for measuring oil pressure.
Fuel pressure gauge	Used for measuring fuel pressure.

E: PROCEDURE

It is possible to conduct the following service procedures with engine on vehicle, however, the procedures described in this section are based on the condition that the engine is removed from vehicle.

- V-belt
- Timing belt
- Valve rocker assembly
- Camshaft
- Cylinder head